

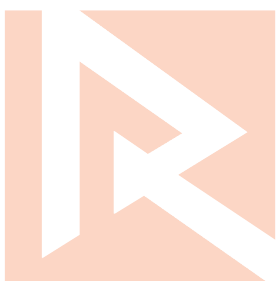

**reventon**  
INDUSTRIAL SOLUTIONS

Technical documentation  
**DTR**





**reventon**  
INDUSTRIAL SOLUTIONS

**Table of contents**

- 1. INTRODUCTION
- 1.1 PRECAUTIONS
- 1.2 TRANSPORT
- 1.3 PACKAGE CONTENT
- 1.4 USE AND PRINCIPLE OF OPERATION
- 2. DEVICE CONSTRUCTION, DIMENSIONS, TECHNICAL DATA
- 2.1 CONSTRUCTION
- 2.2 DIMENSIONS
- 2.3 TECHNICAL DATA
- 3. ASSEMBLY
- 4. INSTALLATION INSTRUCTIONS
- 5. PRECAUTIONS & WARNINGS
- 6. CONTROLS
- 7. CONNECTION SCHEMES
- 8. TERMS OF WARRANTY
- 8.1 WARRANTY CARD
- 8.2 WARRANTY FORM
- 8.3 SERVICE FORM

**1. INTRODUCTION**

Thank you very much for purchasing Reventon Group device. We would like to congratulate you on good choice.

**1.1 PRECAUTIONS**

The buyer and the user of the device should read carefully the following instructions and proceed to the content recommendations. Proceeding due to the following instruction guarantees the correct usage and safety. In case of any doubts please contact the producer. The producer reserves the rights to make changes to the technical documentation without previous notice. The producer is not responsible for the damages which occur due to improper installation, not keeping the device in repair or using the device out of line. The installation should be carried out by the professional installers, who possess the qualifications to install these types of devices. The installers are responsible for making the installation as instructed in the technical data. Regulations and safety rules must be followed. During the installation, use, service and periodical inspections all regulations and safety rules must be followed. In case of unserviceable please plug out the device and contact with the authorized person or the producer.

**1.2 TRANSPORT**

During the acceptance of goods it is needed to check the device in order to exclude any damages. During the transport it is needed to use the proper equipment, it is necessary to carry the device by two people. In case of any damages please fill in the damage report in presence of the supplier.

**1.3 PACKAGE CONTENT**

- Heater
- Operation and maintenance manual and warranty card

**1.4 USE AND PRINCIPLE OF OPERATION**

Devices Reventon Group HC series are used to heat spaces such as: production halls, warehouses, commercial room, service spaces, garages, workshops, greenhouses, tents, shops, malls, shopping malls and churches. Air water heaters have to be connected to central heating system. Application of new technologies in Reventon Group devices guarantees high effectiveness and comfort of the consumption. Original colors of the devices match to every interior. The device is made very precisely and will work smoothly for many years.

\*The product has got the three years of warranty.

\*Lifetime warranty for EPP casing.

**2. DEVICE CONSTRUCTION, DIMENSIONS, TECHNICAL DATA**

**2.1 CONSTRUCTION**

- Casing
- Air stators
- Heating coil
- Axial blowing fan
- Rotating mounting bracket

**Casing:** made of expanded polypropylene EPP, resistant, light and reliable. The material is capable of carrying considerable loads without deforming. It does not degrade under the influence of a lubricant, oil, crude oil and the majority of chemicals. It has an excellent sound insulation properties, that is why it is used as casings, material is environmentally friendly and "green", i.e. 100% recyclable. Aesthetic design gives new nature to the device.

**Air stators:** made of polypropylene PP. It is possible to adjust manually the air stators to achieve the needed direction of the air flow.

**Heating coil:** made of aluminum and copper. The temperature of the heating factor is 120°C; maximum pressure 1,6 MPa; headers diameter 3/4". Depending on the water heater model we offer 1, 2 and 3 heating coils.

**Axial blowing fan:** protective grid made of steel wire galvanized, metal blades. The motor has got the safety degree IP 54. Rate current 0,82A-1,2A. 1-phase device. Depending on the water heater model we offer fans with a diameter 400-450 mm.

**Rotating mounting bracket:** made of steel, element for mounting the device on the wall or ceiling. Solid and durable construction, possible to assemble device in parallel on the angle 60° and 45°. Possible rotation horizontally.

**2.2 DIMENSIONS**

HC20, HC30, HC 35, HC 45

- height: 598mm (a)
- width: 636mm (b)
- depth: 320 mm (c)

HC50, HC70

- height: 698mm (a)
- width: 739mm (b)
- depth: 340 mm (c)

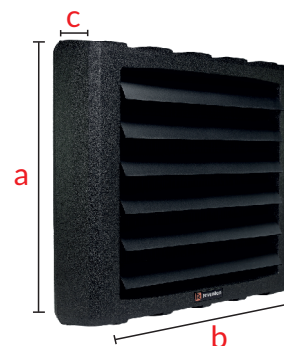

**2.3 TECHNICAL DATA**

Technical data	Unit of measure	HC20 / HC3P 20	HC30 / HC3P 30	HC35 / HC3P 35	HC45 / HC3P 45	HC50 / HC3P 50	HC70 / HC3P 70
Nominal heating capacity water 90/70°C and inlet air temperature 0°C	kW	22,4	26,4	33,9	43,3	46,7	68,5
Heating power range	kW	8-22,4	9,05-26,4	12,9-33,9	18,4-43,3	20,1-46,7	30-68,5
Maximum airrow	m³/h	4100	4000	4000	3600	4600	4400
Maximum range of air stream	m	25	25	25	22	25	25
Number of rows	pcs	1	1	2	2	2	3
Capacity of water	dm³	0,65	0,8	1,35	1,7	1,95	2,85
Air temperature rise *	°C	17,8	25,2	28,6	46,7	29,6	46,5
Maximum temperature of heating agent	°C	120	120	120	120	120	120
Maximum operating pressure	MPa	1,6	1,6	1,6	1,6	1,6	1,6
Rated current	A	0,82/0,47	0,82/0,47	0,82/0,47	0,82/0,47	1,2/0,6	1,2/0,6
Power supply voltage	V/Hz	230-50/400	230-50/400	230-50/400	230-50/400	230-50/400	230-50/400
Motor power	W	180	180	180	180	250	250
Motor speed	rev/min	1380	1380	1380	1380	1350	1350
Motor IP	-	54	54	54	54	54	54
Connection diameter	"	3/4	3/4	3/4	3/4	3/4	3/4
Weight	kg	11,5	12	12,5	14	17,5	19,5
Noise **	dB	50	50	50	50	50	50

\*Temperature rise according to parameters: water 90/70°C and inlet air temperature 0°C

\*\* The measurement at a distance of 5 m from the unit

Parameters	HC20-5 bieg 4100 m3/h				
Inlet and outlet water temperature [°C]	90/70				
Inlet air temperature [°C]	0	5	10	15	20
Heating capacity [kW]	22,4	20,6	18,8	17,1	15,4
Outlet air temperature [°C]	17,8	21,7	25,5	29,4	33,2
Water flow [m³/h]	0,99	0,91	0,83	0,75	0,68
Pressure drop in the heat exchanger [kPa]	6	5	4	4	3

Parameters	HC20-5 bieg 4100 m3/h				
Inlet and outlet water temperature [°C]	80/60				
Inlet air temperature [°C]	0	5	10	15	20
Heating capacity [kW]	18,9	17,1	15,4	13,7	12,1
Outlet air temperature [°C]	15	18,9	22,7	26,5	30,3
Water flow [m³/h]	0,83	0,75	0,68	0,6	0,53
Pressure drop in the heat exchanger [kPa]	5	4	3	2	2

Parameters	HC20-5 bieg 4100 m3/h				
Inlet and outlet water temperature [°C]	70/50				
Inlet air temperature [°C]	0	5	10	15	20
Heating capacity [kW]	15,3	13,6	12	10,3	8,74
Outlet air temperature [°C]	12,2	16	19,9	23,7	27,5
Water flow [m³/h]	0,67	0,6	0,52	0,45	0,38
Pressure drop in the heat exchanger [kPa]	3	3	2	1	1

Parameters	HC20-5 bieg 4100 m3/h				
Inlet and outlet water temperature [°C]	50/30				
Inlet air temperature [°C]	0	5	10	15	20
Heating capacity [kW]	8,3	6,71	5,18	3,69	2,26
Outlet air temperature [°C]	6,6	10,4	14,3	18,1	21,9
Water flow [m³/h]	0,36	0,29	0,22	0,16	0,1
Pressure drop in the heat exchanger [kPa]	1	1	0	0	0

Parameters	HC30-5 bieg 4000 m3/h				
Inlet and outlet water temperature [°C]	90/70				
Inlet air temperature [°C]	0	5	10	15	20
Heating capacity [kW]	26,8	24,6	22,5	20,4	18,4
Outlet air temperature [°C]	23,3	26,8	30,3	33,8	37,2
Water flow [m³/h]	1,18	1,09	0,99	0,9	0,81
Pressure drop in the heat exchanger [kPa]	9	7	6	5	4

Parameters	HC30-5 bieg 4000 m3/h				
Inlet and outlet water temperature [°C]	80/60				
Inlet air temperature [°C]	0	5	10	15	20
Heating capacity [kW]	22,6	20,5	18,4	16,4	14,4
Outlet air temperature [°C]	19,6	23,1	26,6	30	33,4
Water flow [m³/h]	0,99	0,9	0,81	0,72	0,63
Pressure drop in the heat exchanger [kPa]	6	5	4	3	3

Parameters	HC30-5 bieg 4000 m3/h				
Inlet and outlet water temperature [°C]	70/50				
Inlet air temperature [°C]	0	5	10	15	20
Heating capacity [kW]	18,3	16,3	14,3	12,3	10,4
Outlet air temperature [°C]	15,9	19,4	22,9	26,3	29,7
Water flow [m³/h]	0,8	0,71	0,62	0,54	0,45
Pressure drop in the heat exchanger [kPa]	4	3	3	2	1

Parameters	HC30-5 bieg 4000 m3/h				
Inlet and outlet water temperature [°C]	50/30				
Inlet air temperature [°C]	0	5	10	15	20
Heating capacity [kW]	9,83	7,94	6,09	4,31	2,61
Outlet air temperature [°C]	6,5	12	15,5	19	22,4
Water flow [m³/h]	0,43	0,34	0,26	0,19	0,11
Pressure drop in the heat exchanger [kPa]	1	1	1	0	0

Parameters	HC35-5 bieg -4000 m3/h				
Inlet and outlet water temperature [°C]	90/70				
Inlet air temperature [°C]	0	5	10	15	20
Heating capacity [kW]	33,9	31,2	28,5	25,9	23,4
Outlet air temperature [°C]	28,6	31,8	34,9	38,1	41,2
Water flow [m³/h]	1,49	1,37	1,26	1,14	1,03
Pressure drop in the heat exchanger [kPa]	5	4	4	3	4

Parameters	HC35-5 bieg -4000 m3/h				
Inlet and outlet water temperature [°C]	80/60				
Inlet air temperature [°C]	0	5	10	15	20
Heating capacity [kW]	28,7	26	23,4	20,9	18,4
Outlet air temperature [°C]	24,2	27,3	30,5	33,6	36,7
Water flow [m³/h]	1,26	1,14	1,03	0,92	0,81
Pressure drop in the heat exchanger [kPa]	4	3	4	3	2

Parameters	HC35-5 bieg -4000 m3/h				
Inlet and outlet water temperature [°C]	70/50				
Inlet air temperature [°C]	0	5	10	15	20
Heating capacity [kW]	23,4	20,8	18,3	15,9	13,5
Outlet air temperature [°C]	19,7	22,9	26	29,1	32,2
Water flow [m³/h]	1,02	0,91	0,8	0,69	0,59
Pressure drop in the heat exchanger [kPa]	4	3	2	3	2

Parameters	HC35-5 bieg -4000 m3/h				
Inlet and outlet water temperature [°C]	50/30				
Inlet air temperature [°C]	0	5	10	15	20
Heating capacity [kW]	12,9	10,5	8,16	5,89	3,69
Outlet air temperature [°C]	10,9	14	17,1	20,2	23,3
Water flow [m³/h]	0,56	0,46	0,35	0,26	0,16
Pressure drop in the heat exchanger [kPa]	2	4	2	1	4

Parameters	HC45-5 bieg 4000 m3/h				
Inlet and outlet water temperature [°C]	90/70				
Inlet air temperature [°C]	0	5	10	15	20
Heating capacity [kW]	43,3	38,8	35,6	32,5	29,5
Outlet air temperature [°C]	46,7	48,9	51,1	53,2	55,2
Water flow [m³/h]	1,85	1,71	1,57	1,43	1,3
Pressure drop in the heat exchanger [kPa]	27	24	20	17	14

Parameters	HC45-5 bieg 4000 m3/h				
Inlet and outlet water temperature [°C]	80/60				
Inlet air temperature [°C]	0	5	10	15	20
Heating capacity [kW]	36,2	33	29,9	26,9	24
Outlet air temperature [°C]	40,3	42,4	44,5	46,6	48,6
Water flow [m³/h]	1,59	1,45	1,31	1,18	1,05
Pressure drop in the heat exchanger [kPa]	17	16	13	11	10

Parameters	HC45-5 bieg 4000 m3/h				
Inlet and outlet water temperature [°C]	70/50				
Inlet air temperature [°C]	0	5	10	15	20
Heating capacity [kW]	30,3	27,2	24,2	21,2	18,3
Outlet air temperature [°C]	33,7	35,8	37,9	39,9	41,9
Water flow [m³/h]	1,33	1,9	1,06	0,93	0,8
Pressure drop in the heat exchanger [kPa]	14	11	10	8	6

Parameters	HC45-5 bieg 4000 m3/h				
Inlet and outlet water temperature [°C]	50/30				
Inlet air temperature [°C]	0	5	10	15	20
Heating capacity [kW]	18,4	15,4	12,5	9,65	6,78
Outlet air temperature [°C]	20,4	22,5	24,4	26,3	28,1
Water flow [m³/h]	0,8	0,67	0,54	0,42	0,29
Pressure drop in the heat exchanger [kPa]	7	6	4	5	2

Parameters	HC50-5 bieg -4600 m3/h				
Inlet and outlet water temperature [°C]	90/70				
Inlet air temperature [°C]	0	5	10	15	20
Heating capacity [kW]	46,7	43,2	39,7	36,2	32,9
Outlet air temperature [°C]	29,6	32,8	36	39,2	42,3
Water flow [m³/h]	2,06	1,9	1,75	1,6	1,45
Pressure drop in the heat exchanger [kPa]	14	12	10	9	7

Parameters	HC50-5 bieg -4600 m3/h				
Inlet and outlet water temperature [°C]	80/60				
Inlet air temperature [°C]	0	5	10	15	20
Heating capacity [kW]	40,1	36,6	33,2	29,8	26,5
Outlet air temperature [°C]	25,4	28,6	31,8	34,9	38
Water flow [m³/h]	1,76	1,61	1,46	1,31	1,17
Pressure drop in the heat exchanger [kPa]	11	9	8	6	5

Parameters	HC50-5 bieg -4600 m3/h				
Inlet and outlet water temperature [°C]	70/50				
Inlet air temperature [°C]	0	5	10	15	20
Heating capacity [kW]	33,5	30,1	26,7	23,4	20,2
Outlet air temperature [°C]	21,2	24,4	27,5	30,6	33,7
Water flow [m³/h]	1,47	1,32	1,17	1,02	0,88
Pressure drop in the heat exchanger [kPa]	8	6	5	4	3

Parameters	HC50-5 bieg -4600 m3/h				
Inlet and outlet water temperature [°C]	50/30				
Inlet air temperature [°C]	0	5	10	15	20
Heating capacity [kW]	20,1	16,8	13,6	10,4	7,25
Outlet air temperature [°C]	12,7	15,8	18,9	21,9	24,9
Water flow [m³/h]	0,87	0,73	0,59	0,45	0,31
Pressure drop in the heat exchanger [kPa]	3	2	2	1	0

Parameters	HC70-5 bieg -4400 m3/h				
Inlet and outlet water temperature [°C]	90/70				
Inlet air temperature [°C]	0	5	10	15	20
Heating capacity [kW]	68,5	63,3	58,1	53,1	48,2
Outlet air temperature [°C]	46,5	48,7	50,9	53	55,1
Water flow [m³/h]	3,02	2,79	2,56	2,34	2,12
Pressure drop in the heat exchanger [kPa]	19	16	14	12	10

Parameters	HC70-5 bieg -4400 m3/h				
Inlet and outlet water temperature [°C]	80/60				
Inlet air temperature [°C]	0	5	10	15	20
Heating capacity [kW]	59	53,8	48,8	43,9	39,1
Outlet air temperature [°C]	40	42,2	44,3	46,4	48,5
Water flow [m³/h]	2,59	2,36	2,14	1,93	1,72
Pressure drop in the heat exchanger [kPa]	14	12	10	8	7

Parameters	HC70-5 bieg -4400 m3/h				
Inlet and outlet water temperature [°C]	70/50				
Inlet air temperature [°C]	0	5	10	15	20
Heating capacity [kW]	49,4	44,4	39,4	34,6	29,9
Outlet air temperature [°C]	33,5	35,7	37,7	39,8	41,8
Water flow [m³/h]	2,16	1,94	1,73	1,52	1,31
Pressure drop in the heat exchanger [kPa]	11	9	7	5	4

Parameters	HC70-5 bieg -4400 m3/h				
Inlet and outlet water temperature [°C]	50/30				
Inlet air temperature [°C]	0	5	10	15	20
Heating capacity [kW]	30	25,1	20,4	15,7	11
Outlet air temperature [°C]	20,3	22,4	24,4	26,3	28
Water flow [m³/h]	1,3	1,09	0,89	0,68	0,48
Pressure drop in the heat exchanger [kPa]	4	3	2	1	1

### 3. ASSEMBLY

Water heaters Reventon Group HC series can be assembled on the wall or ceiling via rotating mounting bracket. The drawings below show the ways of assembly. In the bigger accommodation it is recommended to assemble more than one device. Follow the parameters which are provided on the drawings.

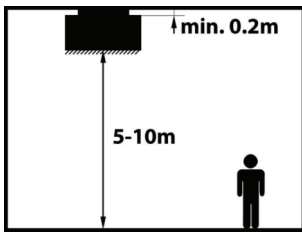

Drawing 2. Assembly on the ceiling.

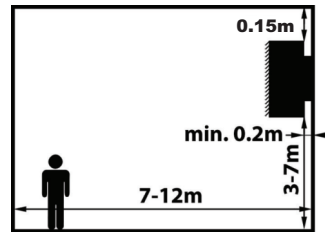

Drawing 3. Assembly on the wall.

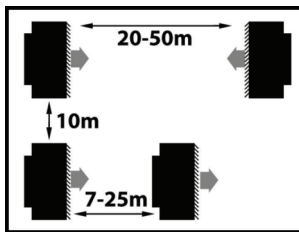

Drawing 4. Example arrangement for few devices in the room.

Reventon Group devices can be assembled on the wall or ceiling via rotating mounting bracket. It is possible to assemble the device in parallel on the angle 60° and 45°. Please follow the parameters as shown below.

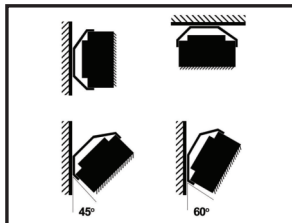

### 4. INSTALLATION INSTRUCTIONS

The installation should be made by the qualified staff, who possess the needed rights to install electrical devices, as instructed in the following documentation. To install the air water heaters Reventon Group HC series use the duct size 2 x 2,5mm<sup>2</sup>.

### 5. PRECAUTIONS & WARNINGS

All works concerning electrical installation should be made by the qualified staff, who possess the qualifications due to the domestic and local norms. These recommendations include service and disassembly as well. Not following to the recommendations may cause electrocution, device damages or its incorrect work.

- Before service or exchange of the device it is obligatory to cut off the current supply.
  - Do not cover the inlet and outlet of the device.
  - Do not use the device in room with high moisture or close to the water basin.
  - Do not install, service the device with wet hands or barefoot.
  - Do not use the device in room with flammable fumes, gas and high concentration of dust.
  - The device should be kept out of reach of children and animals.
  - During the assembly use the filter on the hydraulic supply.
  - Please use the following valves:
    - vent valve in the highest place on the hydraulic installation,
    - cut off valve on the supply and return of the device.
  - The device should be secured against pressure increase in the water installation.
  - Before plugging the electric supply check the leak tightness.
  - The device does not consist of the anti-frost protection. The temperature in the room should not go below 0°C. In such case please empty the device out of water.
  - It is recommended to check the electric installation before the first start.
  - It is recommended to use the external current differential protection.
  - After the turn off, the elements of device may be warm.
  - After operating time of the device, please utilize it concerning the local norms and regulations.
- It is recommended to clean the device periodically:**
- heating coil blow through by compressed air,
  - fan casing and blades clean from the dirt.

- If the device is not used for a longer time disconnect the voltage supply.

- The device is transported with the closed air stators. It is essential to open them in 30 % before first start. Not keeping to the following recommendation may cause the damages of the fan.

- Opening the air stators must be made by two hands in parallel. Not keeping to the following recommendation may cause the damages of the air stators.



While plugging the device to the water installation do remember to hold its stub pipes by pipes spanner, not keeping to the recommendation may cause the damages of the heating coil.

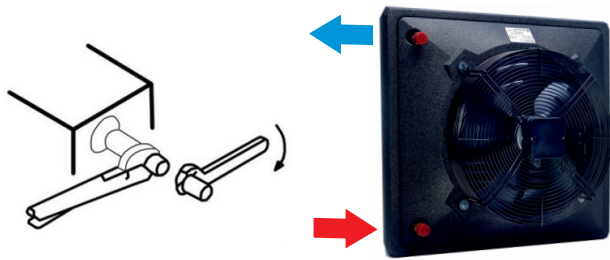

## 6. CONTROLS

To make easier the usage of the Reventon Group devices we also offer the additional controls:

### Fan speed controller HC 1,2A

designed to change the single-phase fan's speed voltage controlled in industrial supply and heating systems



5 control levels: 0-70-85-105- 145-230V  
Power supply voltage: 230V AC/50-60Hz  
Allowable current output: 1,2 A  
Protection: thermal cut-out  
Dimensions: 126mm x 176mm x 56mm  
Weight: 1,3kg  
Degree of protection: IP 54

### Fan speed controller HC 3A

designed to change the single-phase fan's speed voltage controlled in industrial supply and heating systems



5 control levels: 0-70-85-105- 145-230V  
Power supply voltage: 230V AC/50-60Hz  
Allowable current output: 3A  
Protection: thermal cut-out  
Dimensions: 126mm x 176mm x 56mm  
Weight: 1,3kg  
Degree of protection: IP 54

### Fan speed controller HC 5A

designed to change the single-phase fan's speed voltage controlled in industrial supply and heating systems



5 control levels: 0-80-120-140-170-230V  
Power supply voltage: 230V AC/50-60Hz  
Allowable current output: 5A  
Maximum ambient temperature 40°C  
Maximum temperature controller 70°C, limited motor protection.  
Dimensions: 125 mm x 175 mm x 100 mm  
Weight: 3,8 kg  
Degree of protection: IP 54

### Fan speed controller HC 7A

designed to change the single-phase fan's speed voltage controlled in industrial supply and heating systems



5 control levels: 0-80-120-140-170-230V  
Power supply voltage: 230V AC/50-60Hz  
Allowable current output: 7A  
Maximum ambient temperature 40°C  
Maximum temperature controller 70°C, limited motor protection.  
Dimensions: 240 mm x 190 mm x 125 mm  
Weight: 6,4 kg  
Degree of protection: IP 54

### Fan speed controller HC 11A

designed to change the single-phase fan's speed voltage controlled in industrial supply and heating systems



5 control levels: 0-80-120-140-170-230V  
Power supply voltage: 230V AC/50-60Hz  
Allowable current output: 11A  
Maximum ambient temperature 40°C  
Maximum temperature controller 70°C, limited motor protection.  
Dimensions: 240 mm x 190 mm x 125 mm  
Weight: 8,1 kg  
Degree of protection: IP 54

### Fan speed controller HC 14A

designed to change the single-phase fan's speed voltage controlled in industrial supply and heating systems



5 control levels: 0-80-120-140-170-230V  
Power supply voltage: 230V AC/50-60Hz  
Allowable current output: 14A  
Maximum ambient temperature 40°C  
Maximum temperature controller 70°C, limited motor protection.  
Dimensions: 240 mm x 190 mm x 125 mm  
Weight: 10,2kg  
Degree of protection: IP 54

### Two-way valve with actuator HC 3/4" assembly on the return (outlet) pipe



Operating voltage: 230V 50/60 Hz  
Breakaway current: <0,25A  
Input: <0,015 (3,35VA)  
Auxiliary microswitch: 5A  
Max. ambient temperature: 60°C  
Class of insulation: double  
Degree of protection: IP40  
Aperture time: 5-6 min  
Max. height: 3,6 mm

### Programmable room thermostat HC



Numbers of temperature levels: 1  
Hysteresis: 0,50°C/1°C  
Power: 2 batteries AA  
Switching: 230 VAC/50Hz 5(3) A  
Operating temperature range: 0-40°C  
Temperature control range: 5-30°C  
Accuracy of temperature: 0,2°C  
Number of programs: 9

### Room thermostat HC



Operating temperature range: 0-40°C  
Temperature control range: 10-30°C  
Accuracy of temperature: 1°C  
Number of temperature levels: 1



## SPEED CONTROLLERS

### COOPERATION WITH EQUIPMENT

Model	HC 1,2 A	HC 3 A	HC 5 A	HC 7 A	HC 11 A	HC 14 A
Article no.	F5HC-1520	FS3HX-1521	FS5HC-1607	FS7HC-1608	FS11HC-1609	FS14HC-1610
HC20	1	3	6	8	13	17
HC30	1	3	6	8	13	17
HC35	1	3	6	8	13	17
HC45	1	3	6	8	13	17
HC50	1	2	4	5	9	11
HC70	1	2	4	5	9	11
Farmer IP54	1	1	4	5	9	11
Farmer IP65	0	1	2	3	5	7

## 7. CONNECTION SCHEMES

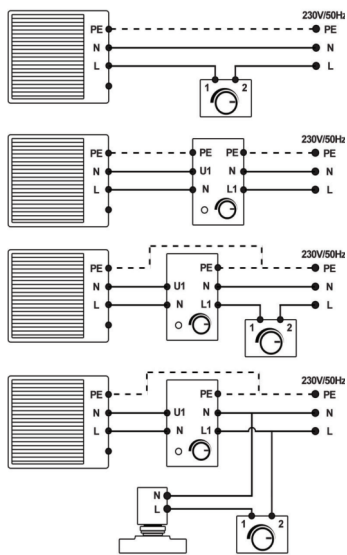

PE- protective earthing, duct yellow-green colour;  
 N- neutral, duct black-black colour;  
 L- phase duct, duct brown colour;  
 Empty clamp, duct blue-black colour.

## 8. TERMS OF WARRANTY

I. Reventon Group Sp. z o.o. [Ltd. ] 3B Montazowa Street , 43-300 Bielsko-Biała, Poland, is the producer of the Reventon Group brand. The warranty concerns the following devices and it is valid for 3 years:

- air heater Reventon Group HC20
- air heater Reventon Group HC30
- air heater Reventon Group HC35
- air heater Reventon Group HC45
- air heater Reventon Group HC50
- air heater Reventon Group HC70

- HC3P 20 22kW 400V
- HC3P 30 26kW 400V
- HC3P 35 34kW 400V
- HC3P 45 43kW 400V
- HC3P 50 47kW 400V
- HC3P 70 69kW 400V

\* lifetime warranty for EPP caisng

II. Warranty is valid in the European Union.

III. The terms of warranty are valid from purchasing the device (the date issuing a document confirming the purchase of the device) but not further than 42 months from leaving the producer's warehouse.

IV. The defects revealed during the warranty period will be removed free of charge in 14 working days. The service will be done by the installation company due to the terms of included in warranty card. The elements will be supplied by the Reventon Group producer during the warranty period.

V. Warranty does not cover the parts of the device subject to normal maintenance and the cases as below:

a) Mechanical defects, damages from the impact of the improper transportation or damages through improper storage.

b) Defects through:

- improper usage and service;

- using the device in the improper conditions (too high humidity, too high or too low temperature, impact of the surrounding, sun etc.);

- modified equipment that has been modified or repaired without written agreement of the producer;

- connecting additional equipment, which is not recommended by the producer or inconsistent with the technical documentation;

- improper power supply.

c) Elements which wear and tear such as discolor or using.

VI. All changes in record in the warranty terms or any constructive modifications, independent service outside the Reventon Group service or use, uncaring, makes the warranty not valid.

VII. To obtain the service it is needed to send to the producer warranty card with the signature, document confirming the purchase, (copy of the invoice) and correctly filled the warranty form.

VIII. Not following to any of warranty regulations makes the warranty not valid.

IX. All correspondence, returns, complains should be send to the following address: Reventon Group Sp. z o.o. 3B Montazowa Street, 43-300 Bielsko-Biała, Poland or e-mail: [serwis@reventongroup.eu](mailto:serwis@reventongroup.eu)

**The producer reserves the rights to make changes to the technical documentation without previous notice.**

# Warranty card



**reventon**  
INDUSTRIAL SOLUTIONS

Reventon Group [Ltd.] 3B Montazowa Street, 43-300 Bielsko-Biała, Poland

---

Stamp and signature of the installation company:

---

Factory number of the device:

---

Address and place of assembly :

---

City:

---

Postal code:

---

Street:

---

Number:

---

Place:



# Warranty form



Reventon Group [Ltd.] 3B Montazowa Street, 43-300 Bielsko-Biała, Poland

---

The company reporting the complaint:

---

The company installing the device:

---

Factory number of the device:

---

Date of assembly:

---

Date and circumstances of noticing the defect:

---

Date of declaration the complaint:

---

Address and place of assembly the device:

---

Contact Name and Surname:

---

Telephone number/ e-mail address:

---

Description of the defect:

# Service card



Reventon Group [Ltd.] 3B Montazowa Street, 43-300 Bielsko-Biała, Poland

Lp.	Date of declaration the complaint	Date of repair	Description of the repair	Service stamp
-----	-----------------------------------	----------------	---------------------------	---------------



**reventon**  
INDUSTRIAL SOLUTIONS

Reventon Group Sp. z o.o. [Ltd.] , 3B Montażowa Street, 43-300 Bielsko-Biała, Poland, [www.reventongroup.eu](http://www.reventongroup.eu)